

INSTALLATION GUIDE - AUSTRALIA

FELTON

TATE AERLUX® CONVENTIONAL SLIDE RAIL

SYSTEM REQUIREMENTS

To ensure the optimum performance and customer satisfaction please adhere to the following:

- Flush out all pipe work prior to installation.
- Installation should comply with relevant local authority requirements.

Operating Pressures	MINIMUM		MAXIMUM
	Hot	Cold	
	70kPa (10.2psi)	70kPa (10.2psi)	500kPa (72.1)
Operating Hot Water Temperatures	55° C		60° C
Operating Cold Water Temperatures	5° C		N/A

Failure to comply with the above will void warranties

AS/NZS 3500.1 states that pressures above 500kPa can cause damage from water hammer, reduce the life of appliances, taps & fittings, cause excessive noise in the system and recommend that a pressure limiting valve (PLV) be fitted.

WHAT IS IN THE PACK

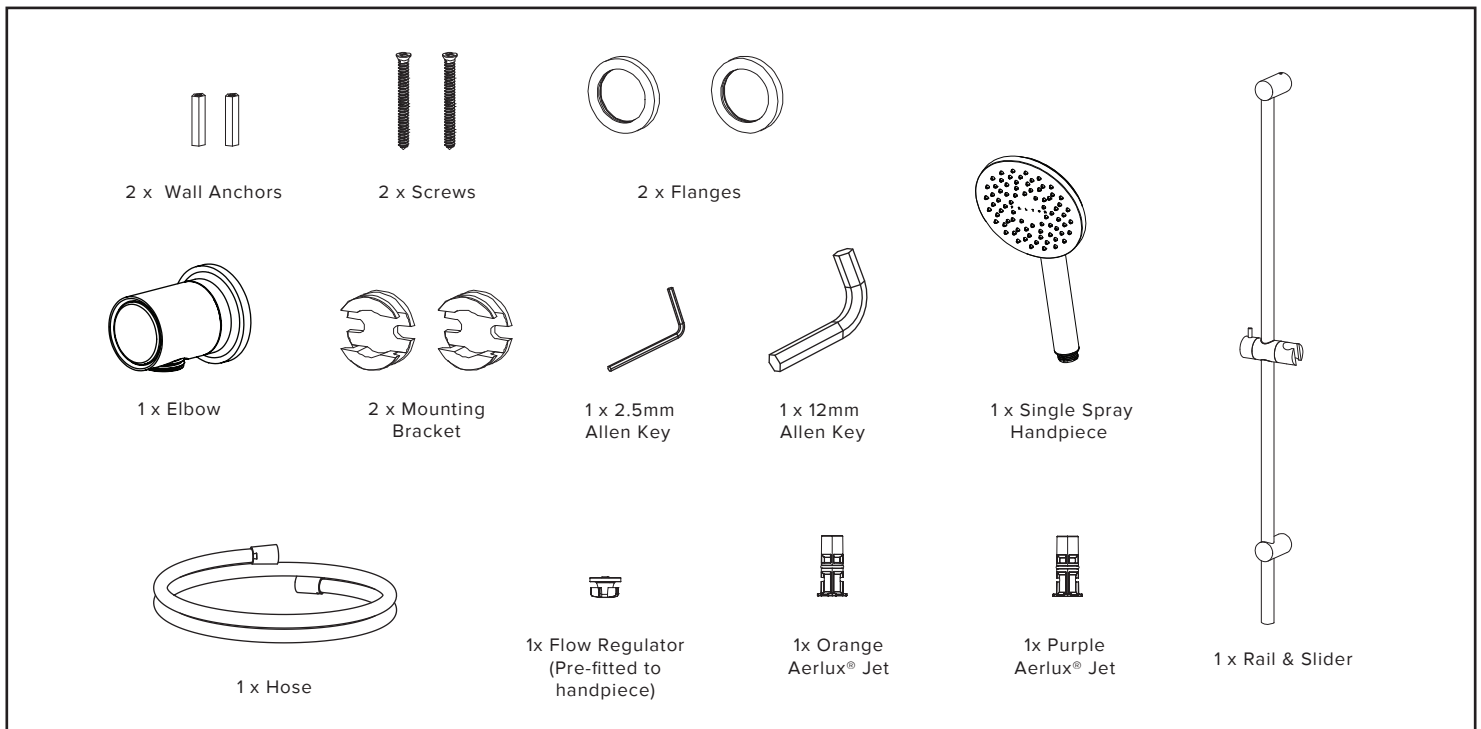

CHOOSING THE AERLUX® JET

For a *softer shower*, install the Orange Aerlux® Jet



With the Flow Regulator fitted

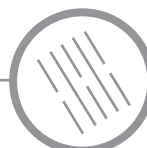

For a *harder shower*, install the Purple Aerlux® Jet



HOW TO INSTALL

INSTALLING INTO STUD/NOG...(RECOMMENDED)

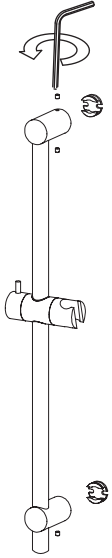
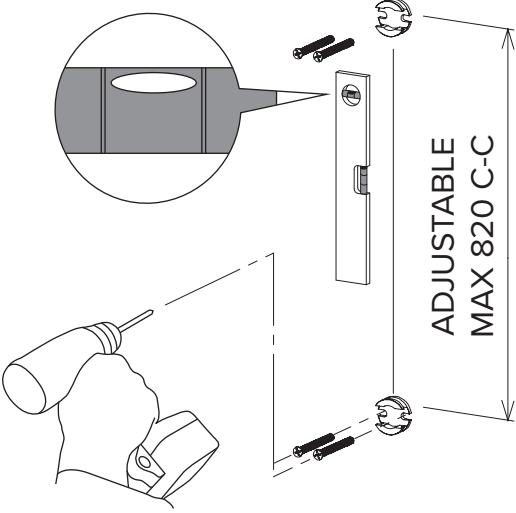
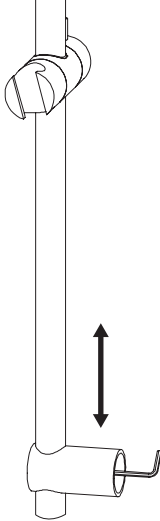
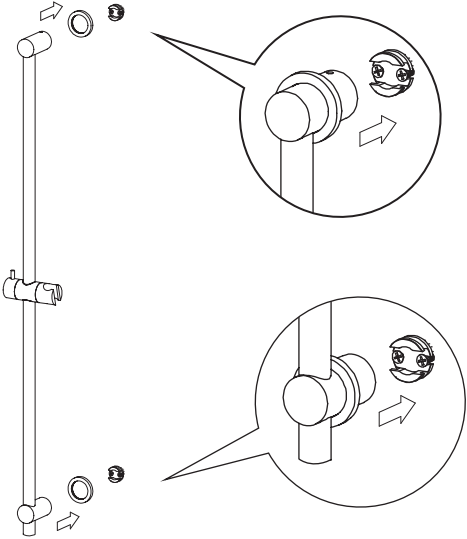
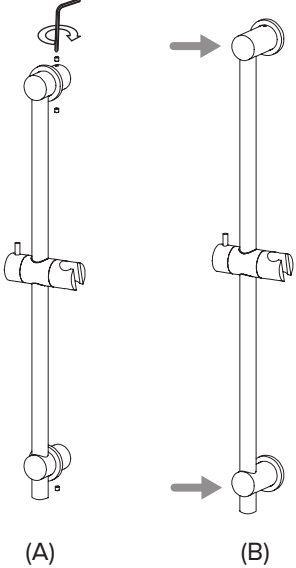
	 <p>ADJUSTABLE MAX 820 C-C</p>	
<p>1. Untighten the grub screws from the top and bottom of the rail with a 2.5mm allen key and remove the mounting brackets.</p>	<p>2. Screw the mounting brackets into the desired position on the wall (adjustable MAX 820mm c-c), ensuring that they are in the correct orientation. Sealant may be required on the screws to achieve a water tight seal.</p>	<p>3. Adjust the bottom bracket on the rail, using a 2.5mm allen key to loosen and tighten the grub screw inside the back of the bracket.</p>
	 <p>(A) (B)</p>	
<p>4. Fit the flanges over both brackets of the rail. Then mount the rail onto the brackets in place. Ensure that both rail and bracket are secured.</p> <p>It is recommended that silicone sealant be used to seal the fixing brackets.</p>	<p>5. Tighten the grub screws on the rail with an allen key (A). Push the flanges firmly against the wall (B).</p>	

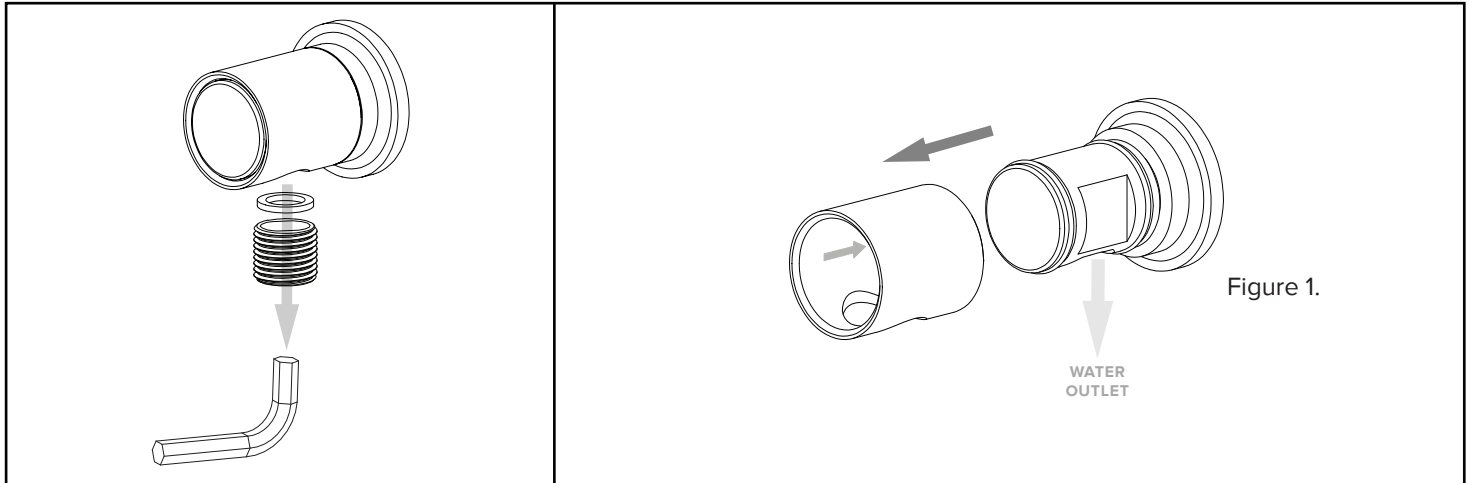

Figure 1.

6. Unscrew the nipple from the elbow with the 12mm allen key provided and remove the rubber gasket and nipple.

7. Remove the elbow sleeve from the elbow body. Screw elbow onto the water outlet (wingback) on the wall. Sealant is required on thread to achieve water tight seal. Ensure the water outlet on the elbow is facing downwards. (Figure 1).

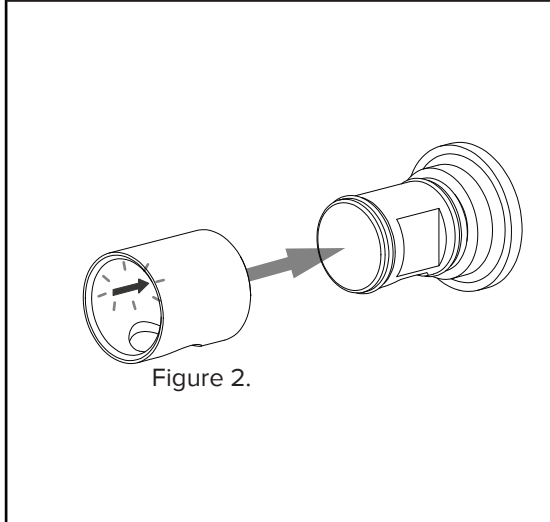
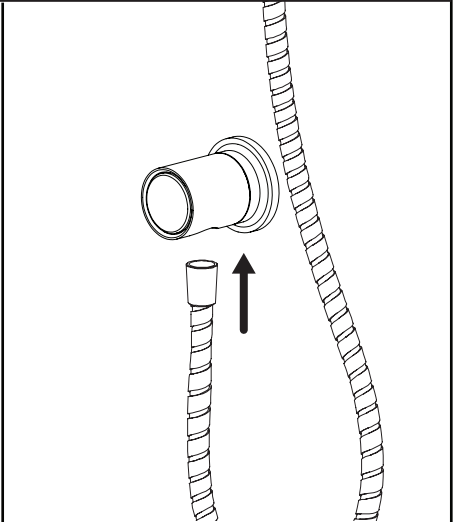
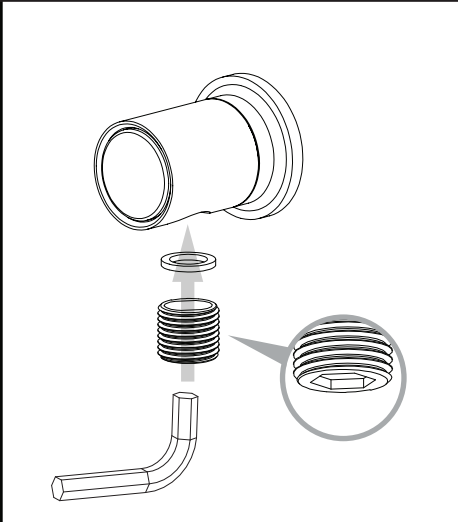

Figure 2.



8. Fit the elbow sleeve onto the elbow body. Follow the arrow direction inside the sleeve. Ensure the sleeve's hole is aligned with the water outlet. (figure 2)

9. Refit the rubber gasket and screw the nipple back into the elbow with the 12mm allen key provided. Ensure the hex is facing downwards.

10. Fit the hose onto the bottom end of the elbow.

INSTALLING INTO CONCRETE/BRICK WALL...

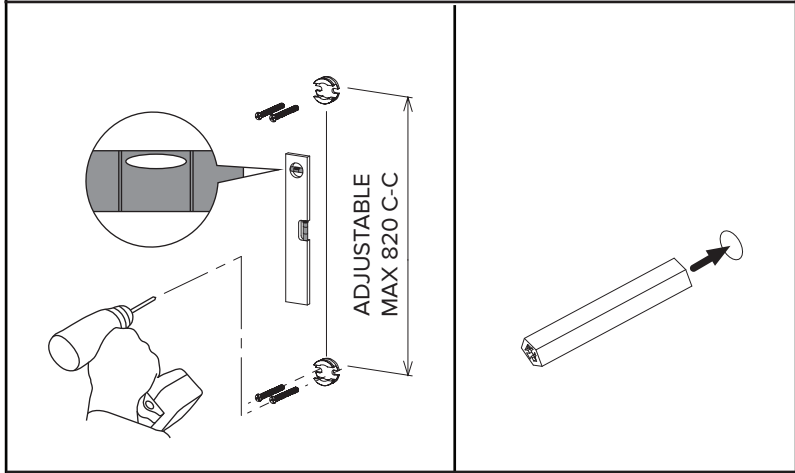

Pre-drill holes to the desired position (adjustable maximum 820mm c-c) and fit the wall anchors then follow the above instructions.

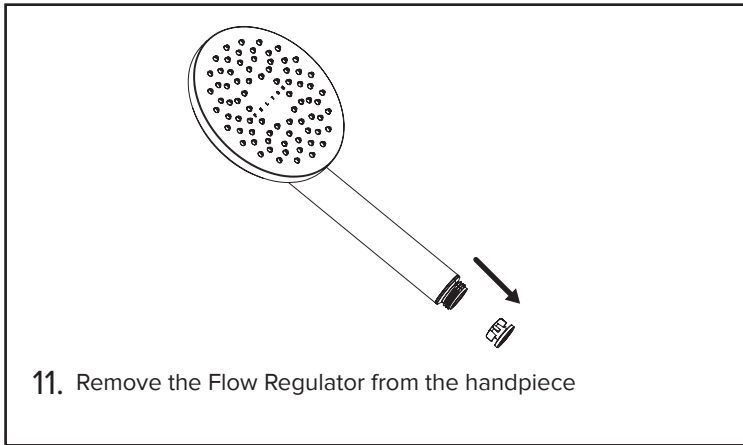

11. Remove the Flow Regulator from the handpiece

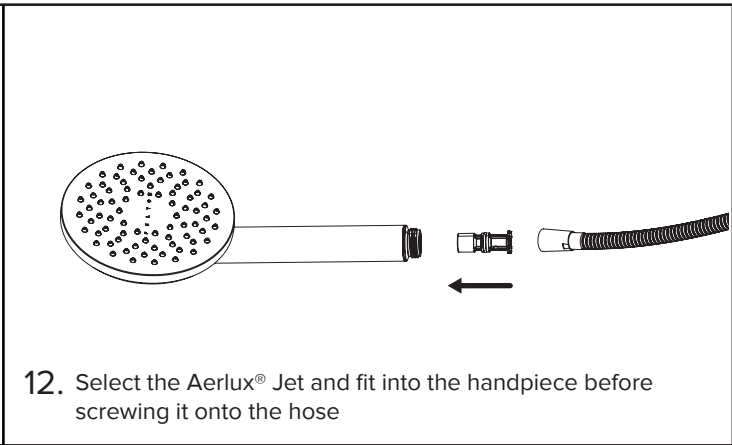

12. Select the Aerlux® Jet and fit into the handpiece before screwing it onto the hose

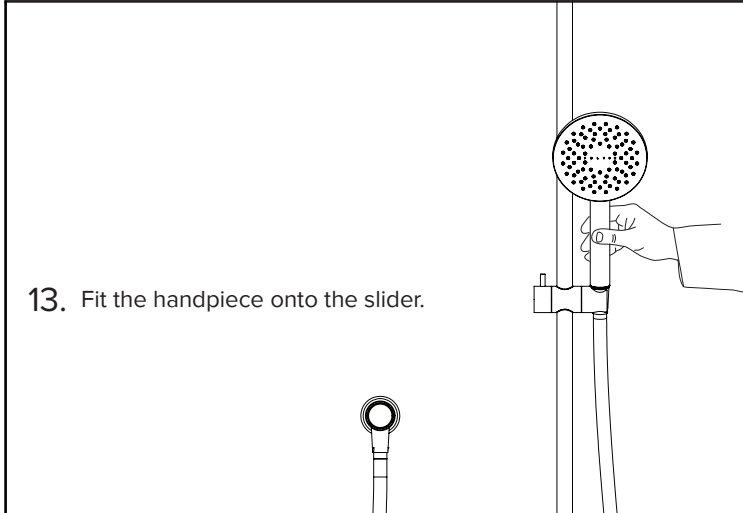

13. Fit the handpiece onto the slider.

Warranty, Maintenance and Care YOUR COPY TO KEEP

Felton Industries Limited guarantees this product to be free from defects in materials and workmanship for a period of five (5) years from the date of purchase. This warranty is effective for 5 years from the date of purchase and covers supply of replacement parts only, not including installation. You must retain proof of purchase of the product (such as an invoice or receipt) and provide this to Felton on request. This warranty is for manufacturing defects only and does not cover any damage to product due to abuse, negligence or improper installation. This warranty is given on the understanding that the product is installed and operated according to Felton's installation guide and the Australian/New Zealand standard AS/NZS3500. This warranty is provided to persons who are a "consumer" under the Consumer Guarantees Act 1993 only and for use in domestic/residential dwellings only (not for commercial use).



At no stage should plated surfaces be cleaned with cleaning agents that contain a corrosive acid or a scouring additive. Plated surfaces should be cleaned with liquid detergent or soap and water. Any damage caused through the use of an unsuitable cleaner will not be covered by warranty. This warranty is subject to any other rights or remedies that you may have under the Consumer Guarantees Act 1993 (or any other applicable legislation) and to Felton's Terms of Trade.

Please fill in the details below, attach your receipt to this installation guide and keep as your proof of purchase.

Purchased at:

Date of purchase:

Installed by:

For technical assistance please ring: 1800 792 760